

10% of Actual Size
Screen Print

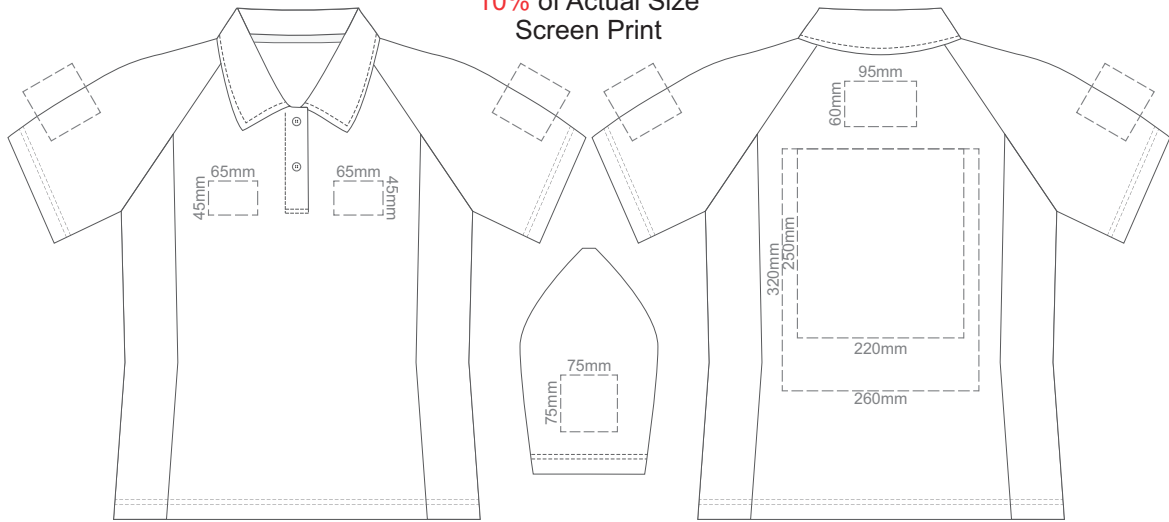

FRONT ADULT EXTRA SMALL

BACK ADULT EXTRA SMALL

10% of Actual Size
Colourflex Transfer

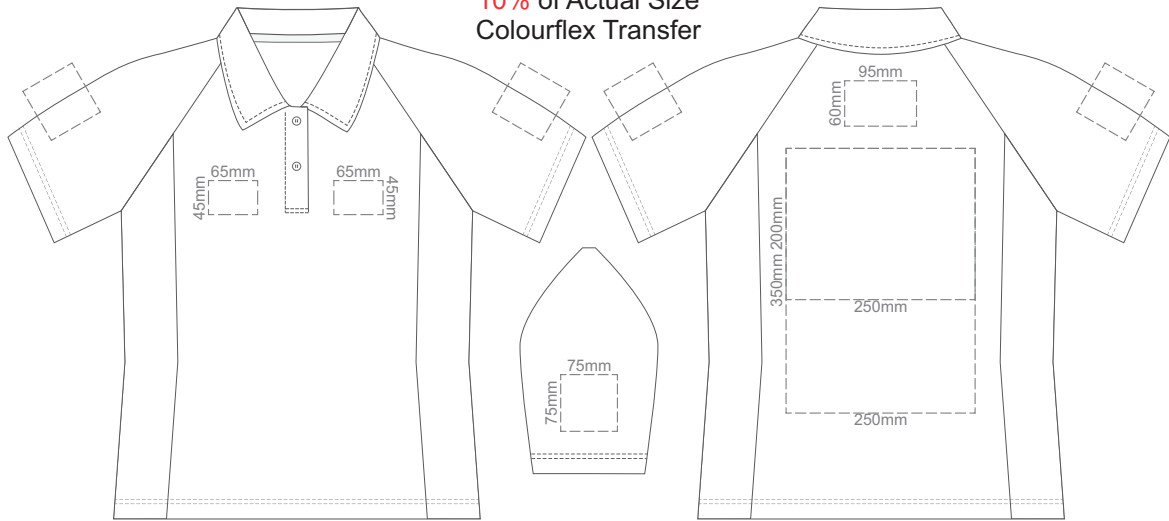

FRONT ADULT EXTRA SMALL

BACK ADULT EXTRA SMALL

Print area 250x200mm can be rotated to best suit.

10% of Actual Size
Embroidery

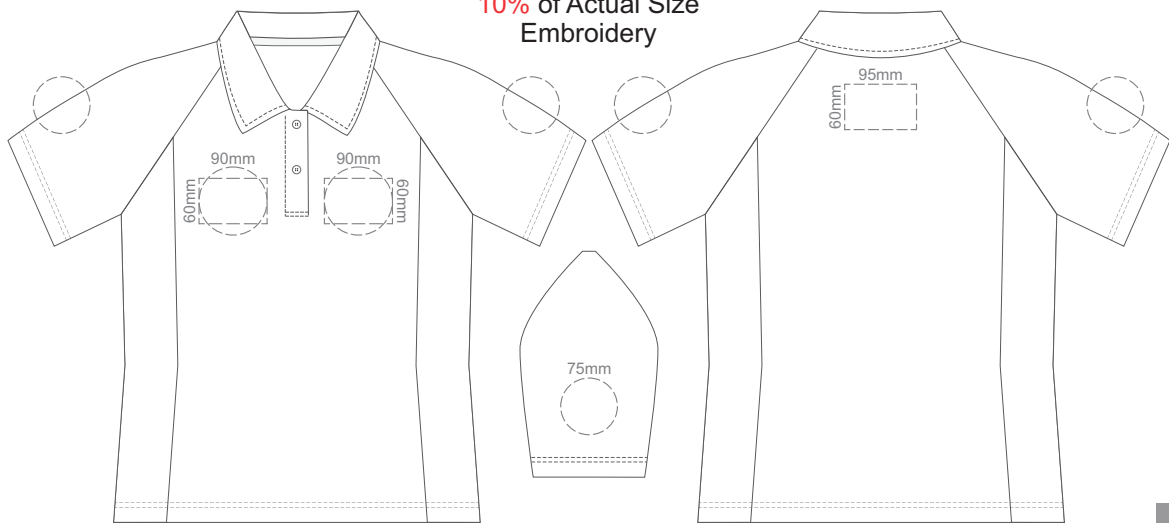

FRONT ADULT EXTRA SMALL

BACK ADULT EXTRA SMALL



10% of Actual Size
Screen Print

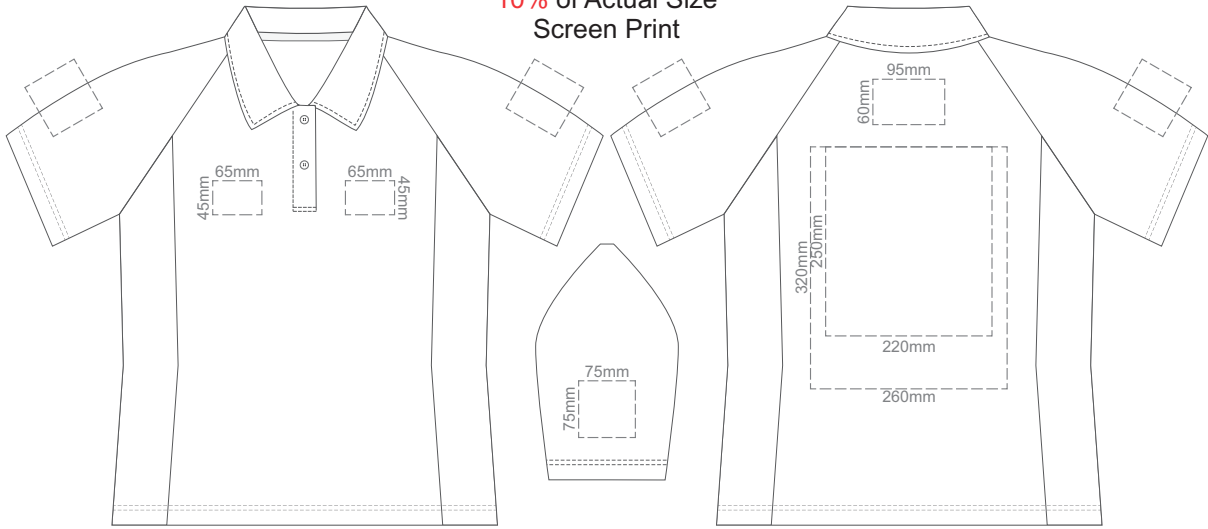

FRONT ADULT SMALL

BACK ADULT SMALL

10% of Actual Size
Colourflex Transfer

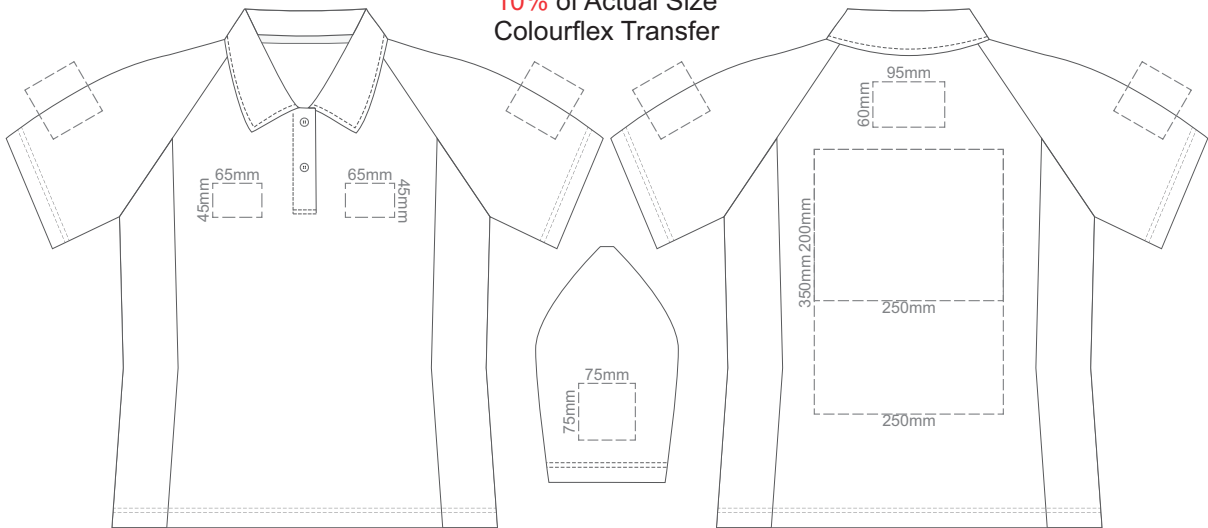

FRONT ADULT SMALL

Print area 250x200mm can be rotated to best suit.

BACK ADULT SMALL

10% of Actual Size
Embroidery

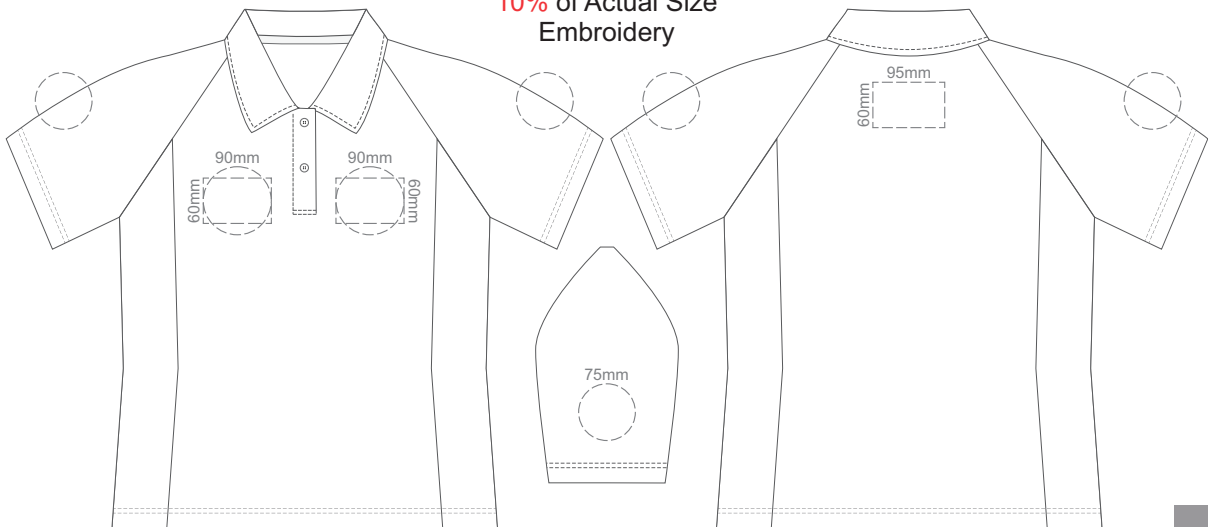

FRONT ADULT SMALL

BACK ADULT SMALL



10% of Actual Size
Screen Print

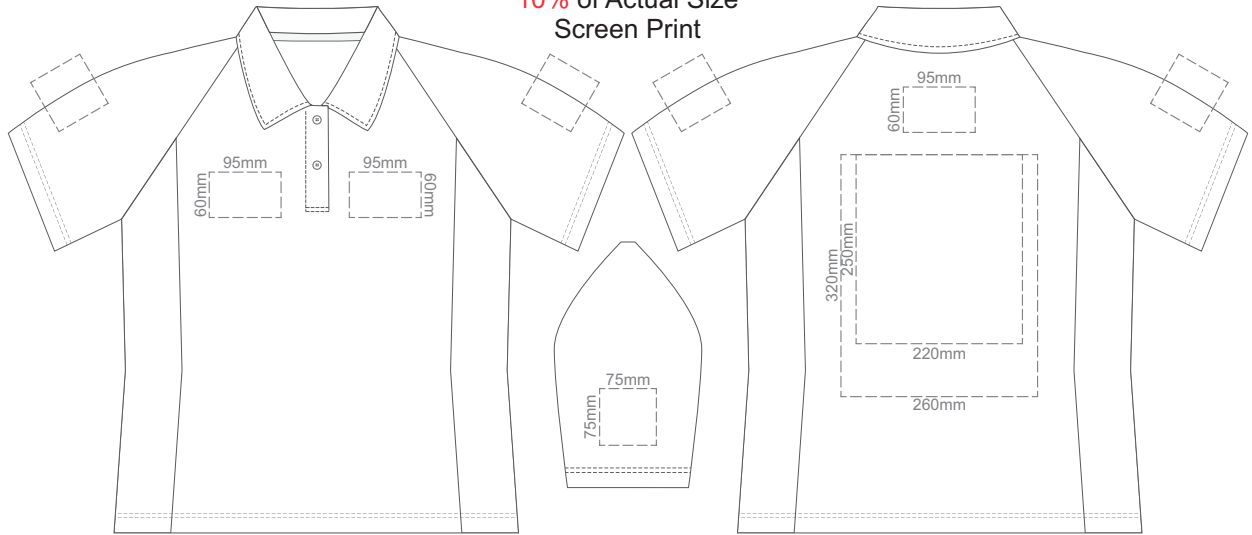

FRONT ADULT MEDIUM

BACK ADULT MEDIUM

10% of Actual Size
Colourflex Transfer

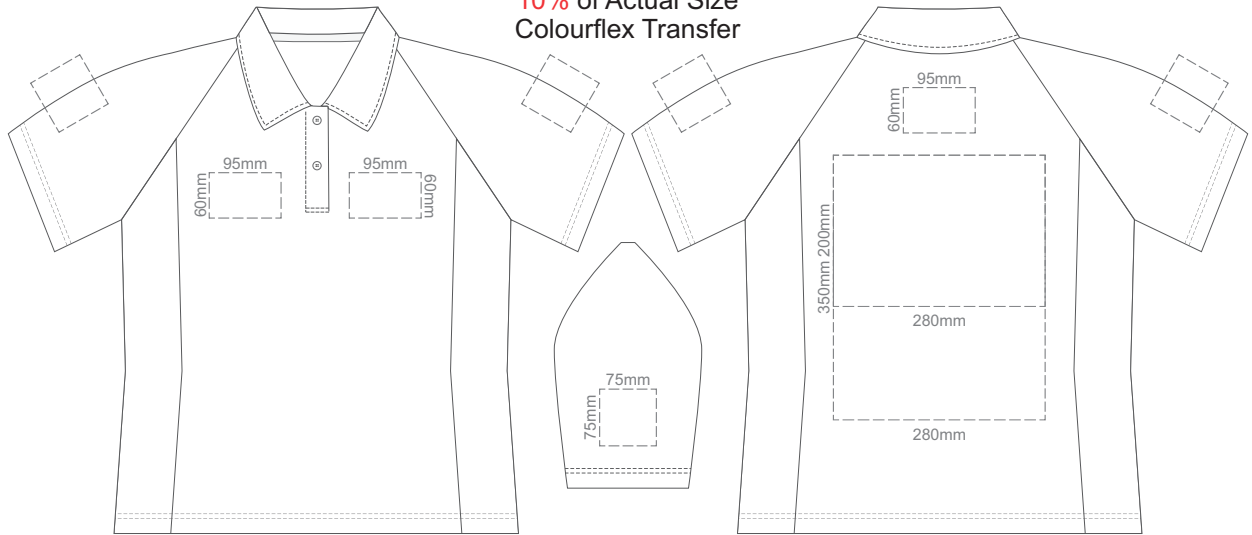

FRONT ADULT MEDIUM

BACK ADULT MEDIUM

Print area 280x200mm can be rotated to best suit.

10% of Actual Size
Embroidery

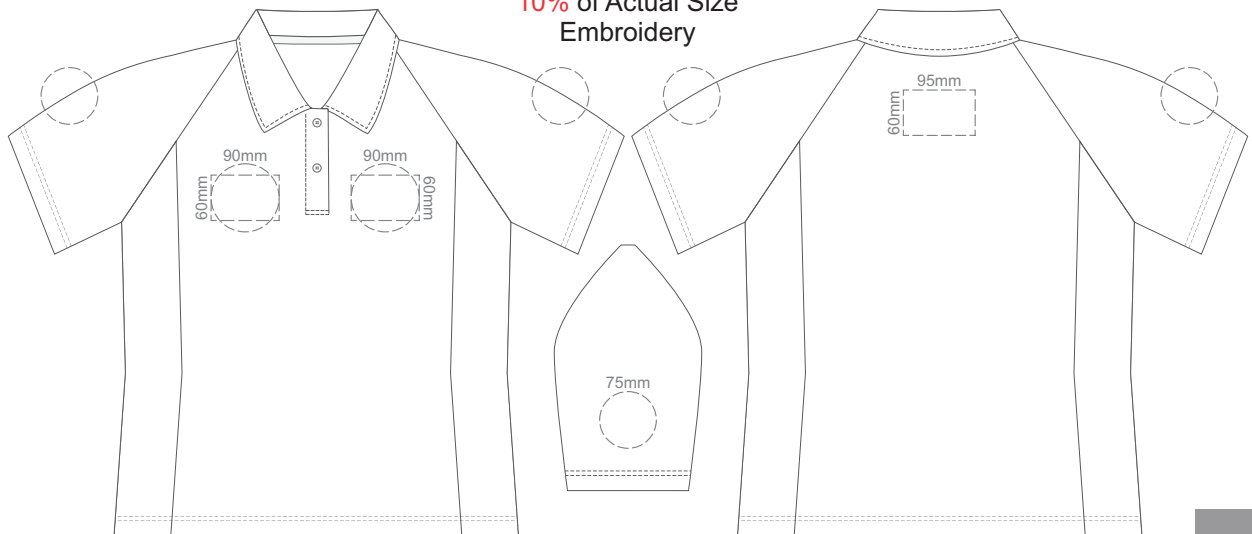

FRONT ADULT MEDIUM

BACK ADULT MEDIUM



100% of Actual Size
Screen Print

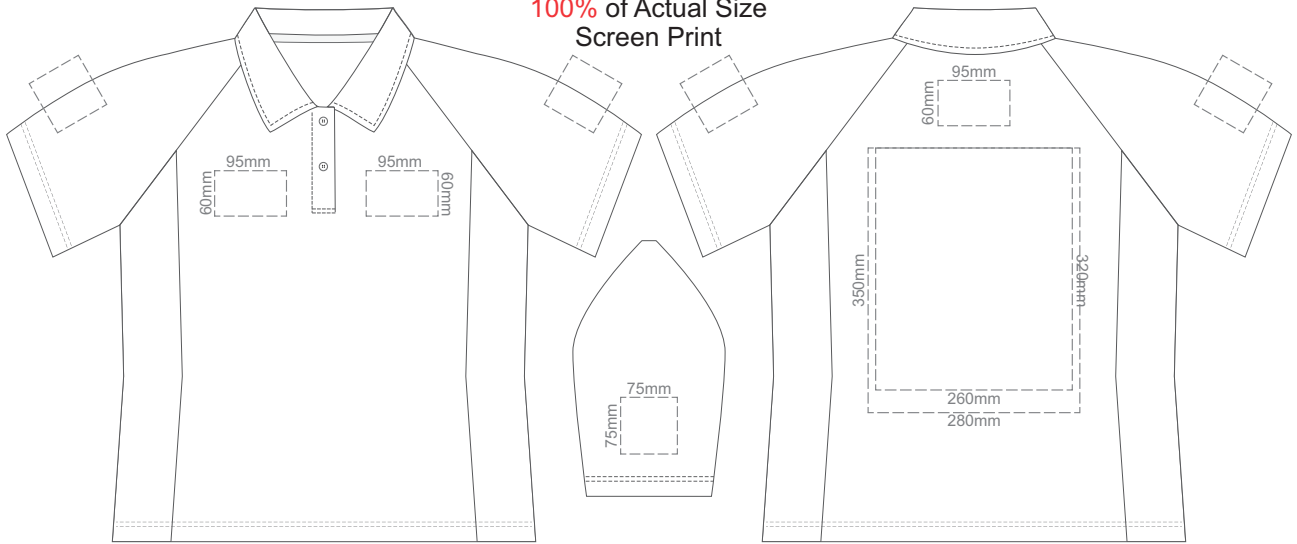

FRONT ADULT LARGE

BACK ADULT LARGE

100% of Actual Size
Colourflex Transfer

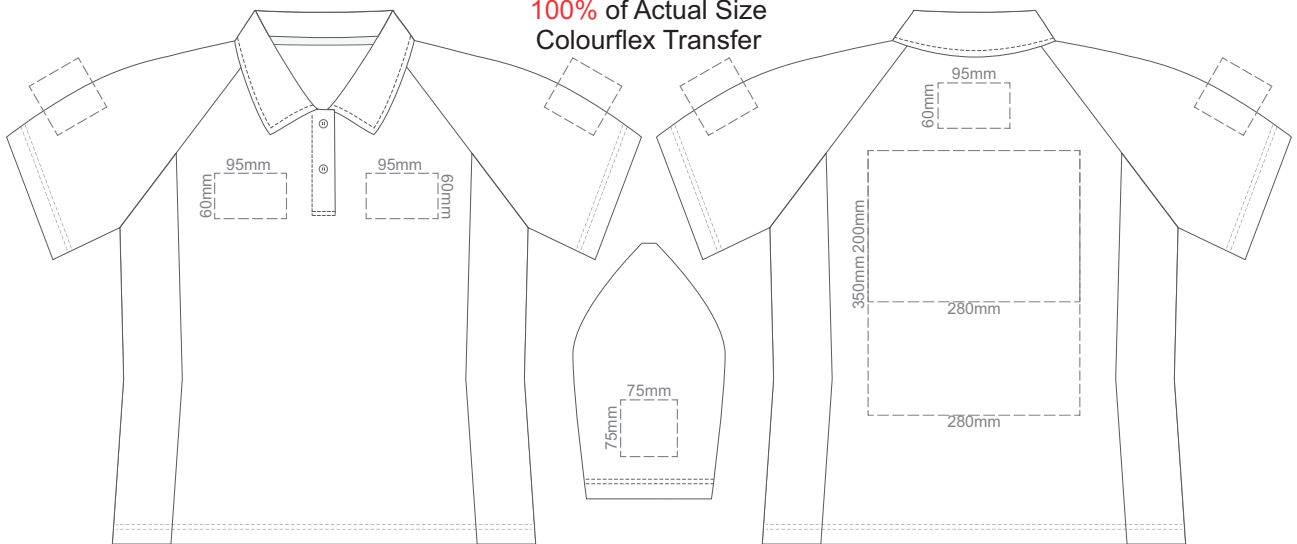

FRONT ADULT LARGE

Print area 280x200mm can be rotated to best suit.

BACK ADULT LARGE

100% of Actual Size
Embroidery

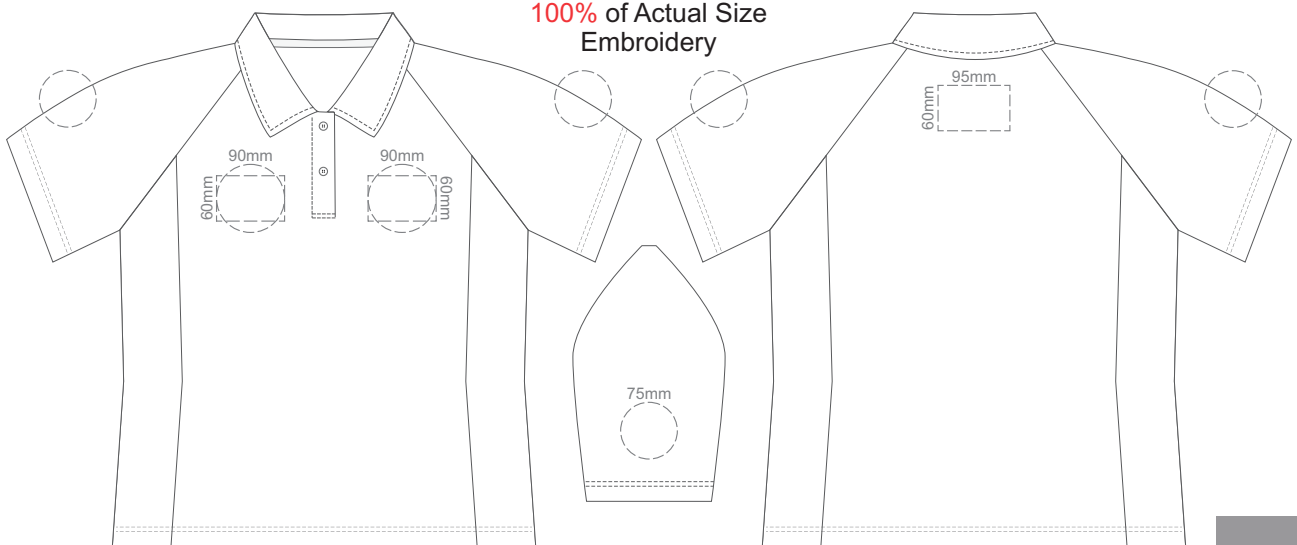

FRONT ADULT LARGE

BACK ADULT LARGE



10% of Actual Size
Screen Print

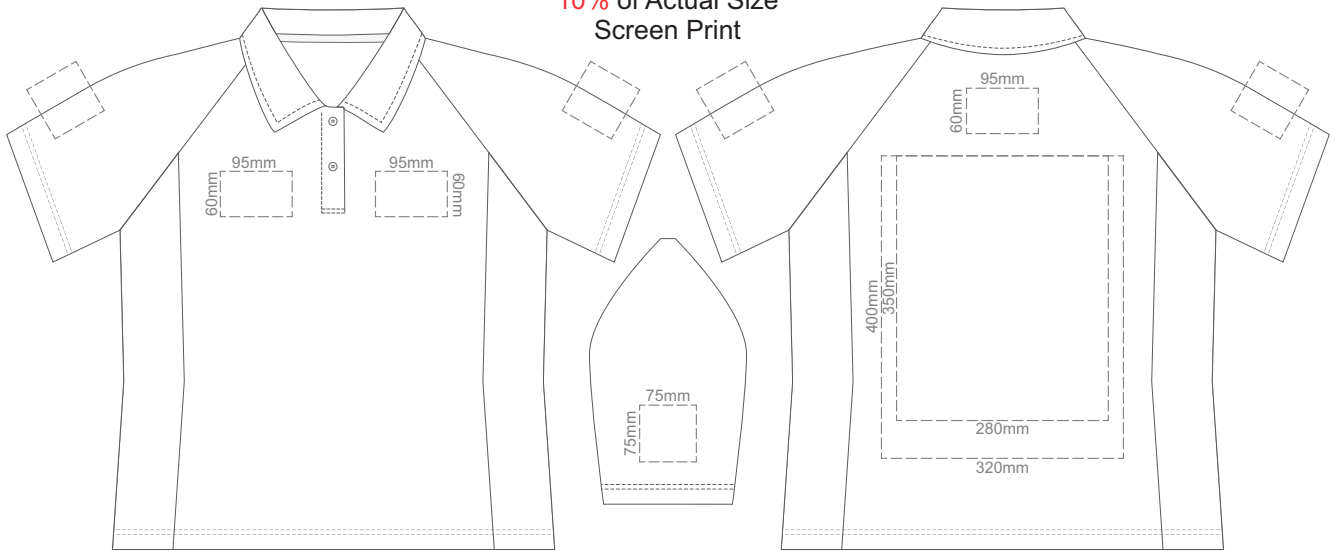

FRONT ADULT XL

BACK ADULT XL

10% of Actual Size
Colourflex Transfer

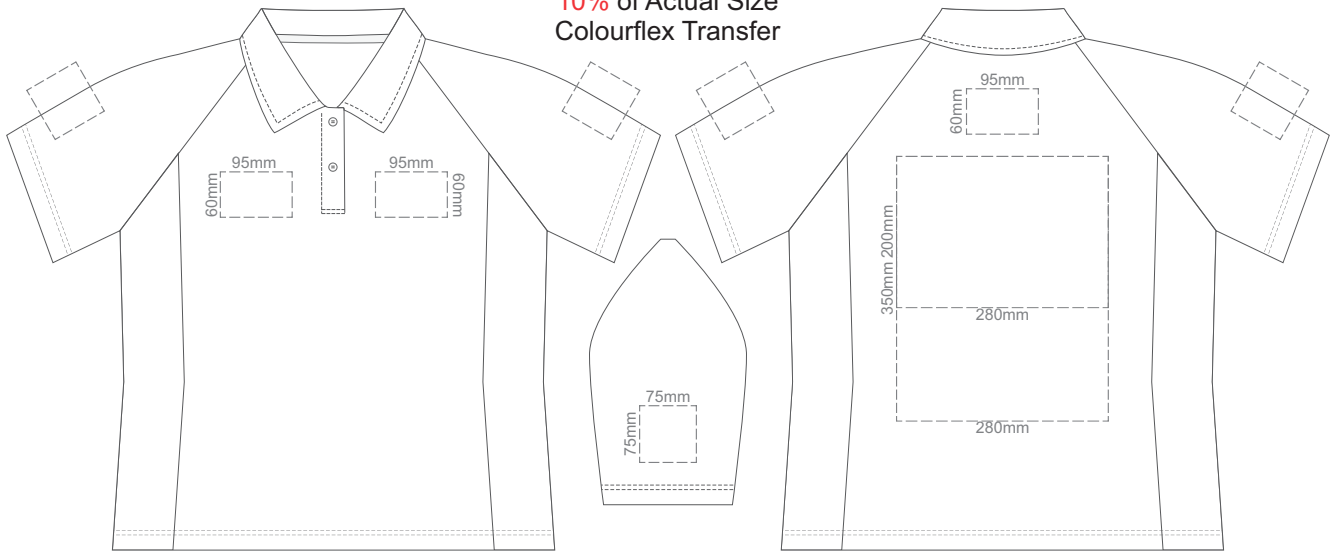

FRONT ADULT XL

Print area 280x200mm can be rotated to best suit.

BACK ADULT XL

10% of Actual Size
Embroidery

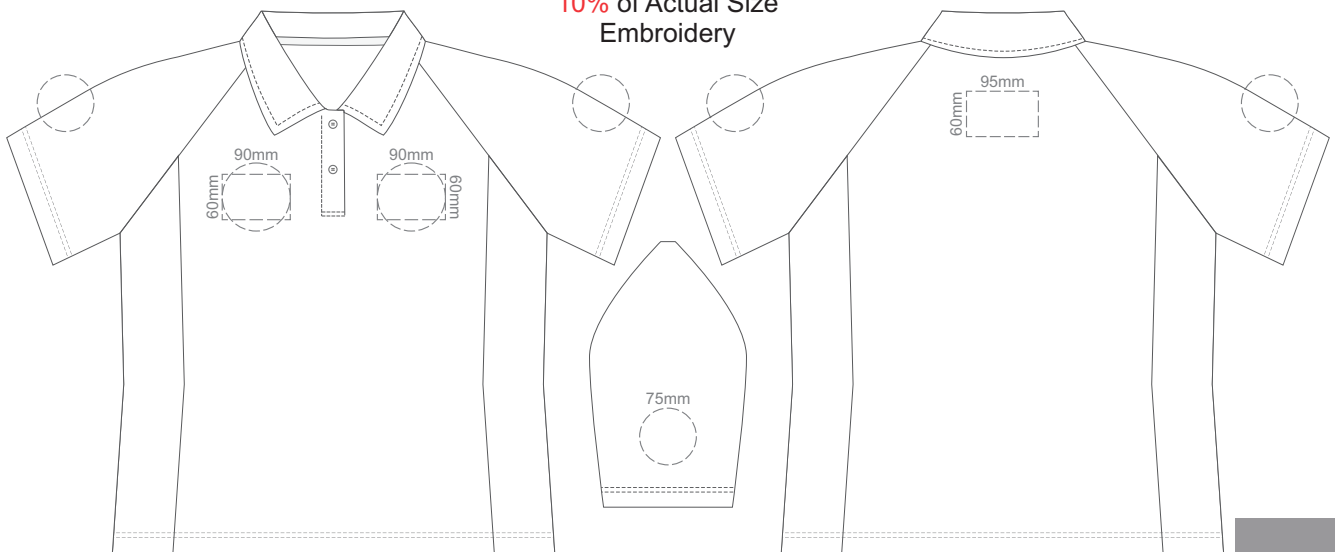

FRONT ADULT XL

BACK ADULT XL



10% of Actual Size
Screen Print

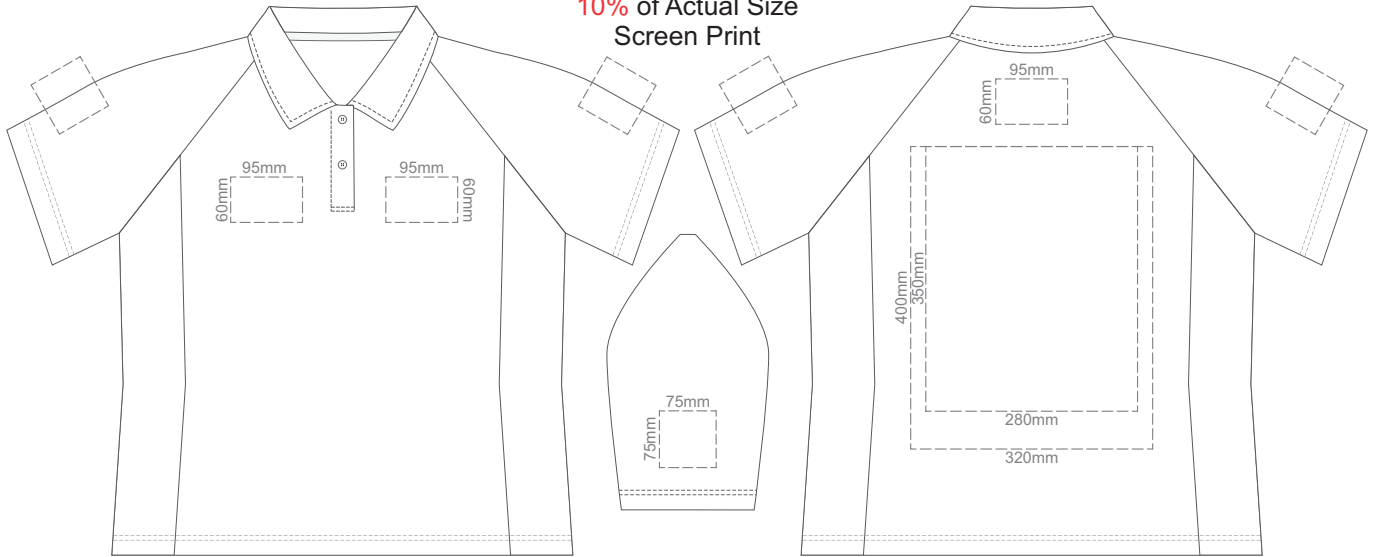

FRONT ADULT 2XL

BACK ADULT 2XL

10% of Actual Size
Colourflex Transfer

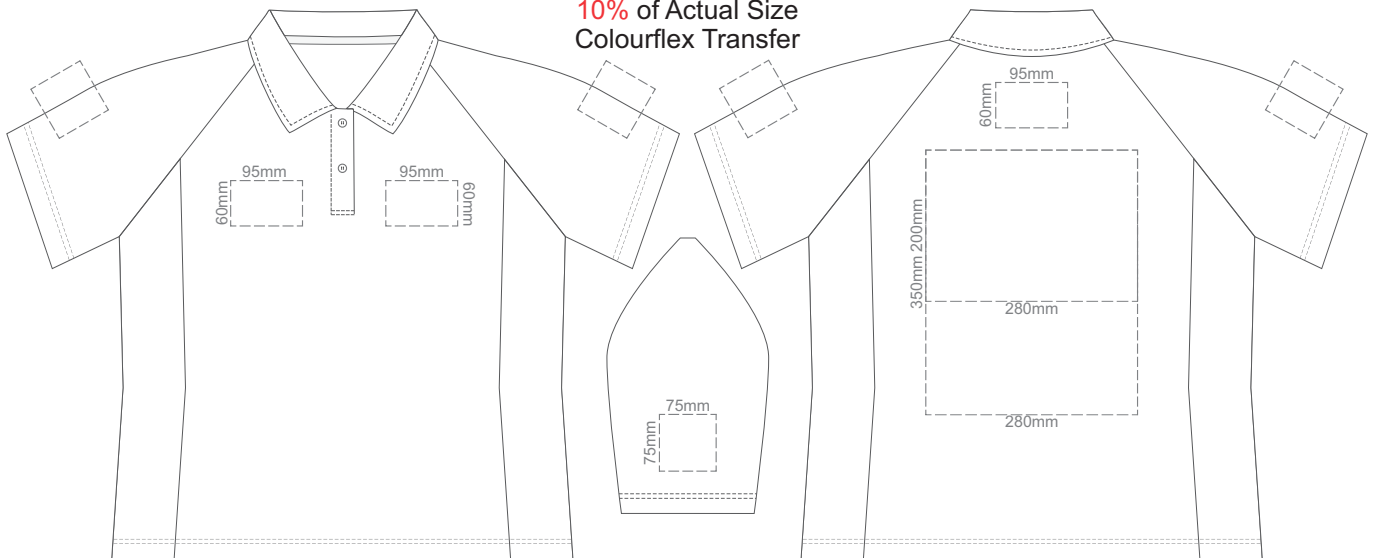

FRONT ADULT 2XL

BACK ADULT 2XL

Print area 280x200mm can be rotated to best suit.

10% of Actual Size
Embroidery

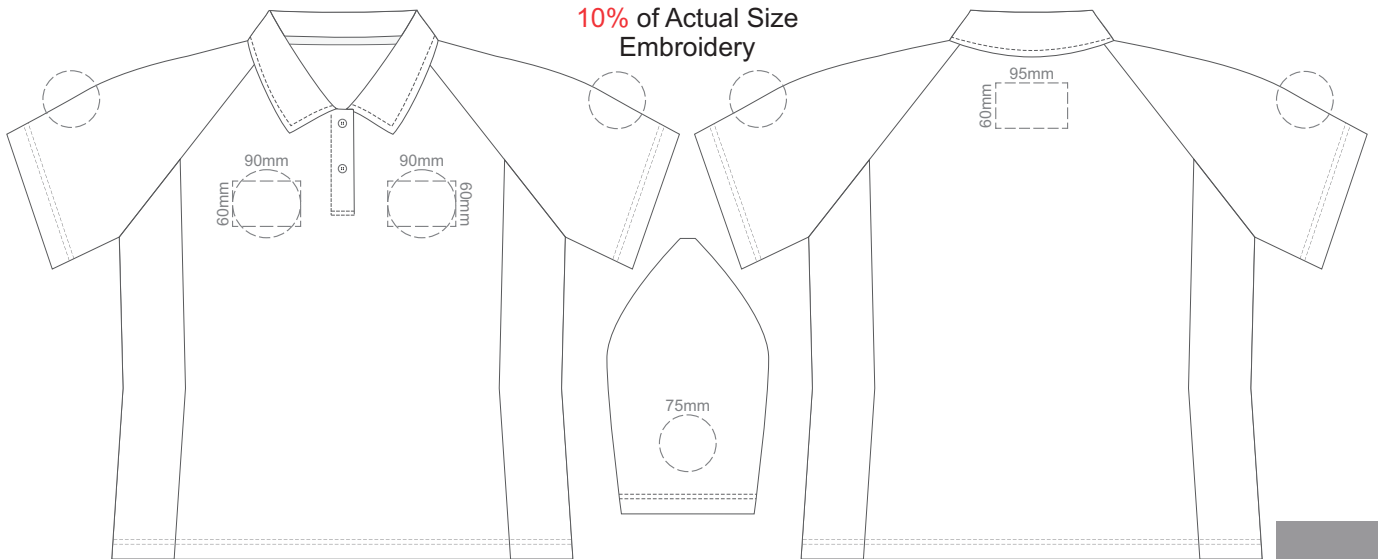

FRONT ADULT 2XL

BACK ADULT 2XL

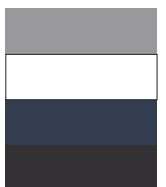

10% of Actual Size
Screen Print

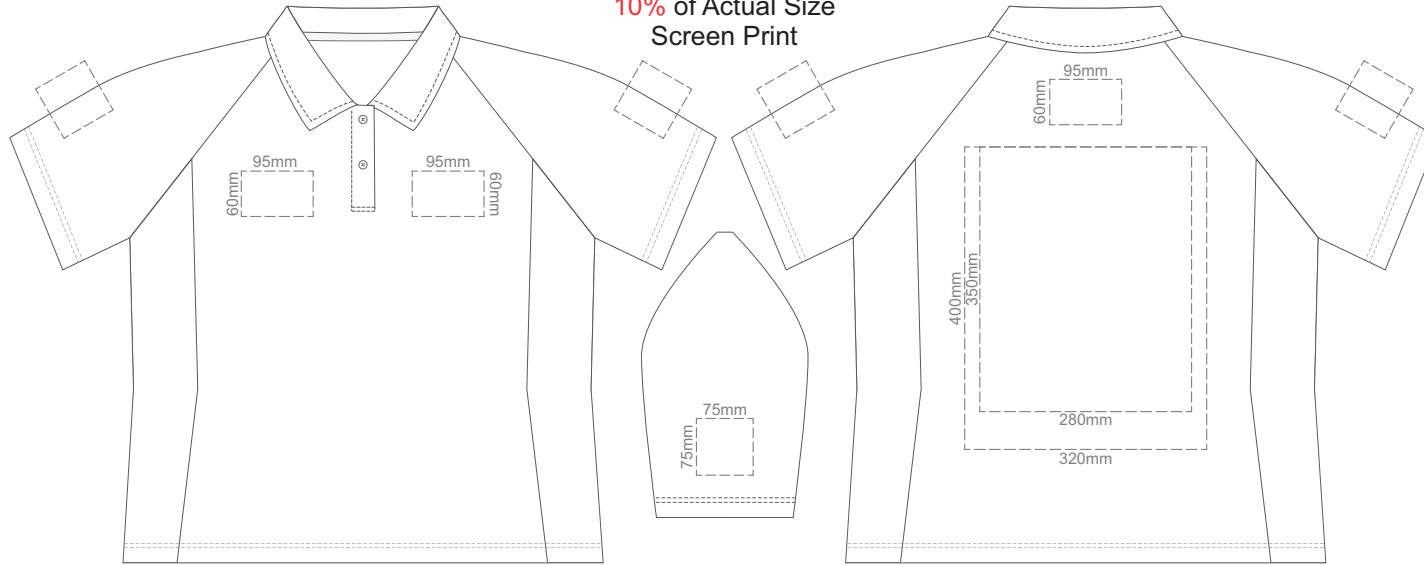

FRONT ADULT 3XL

BACK ADULT 3XL

10% of Actual Size
Colourflex Transfer

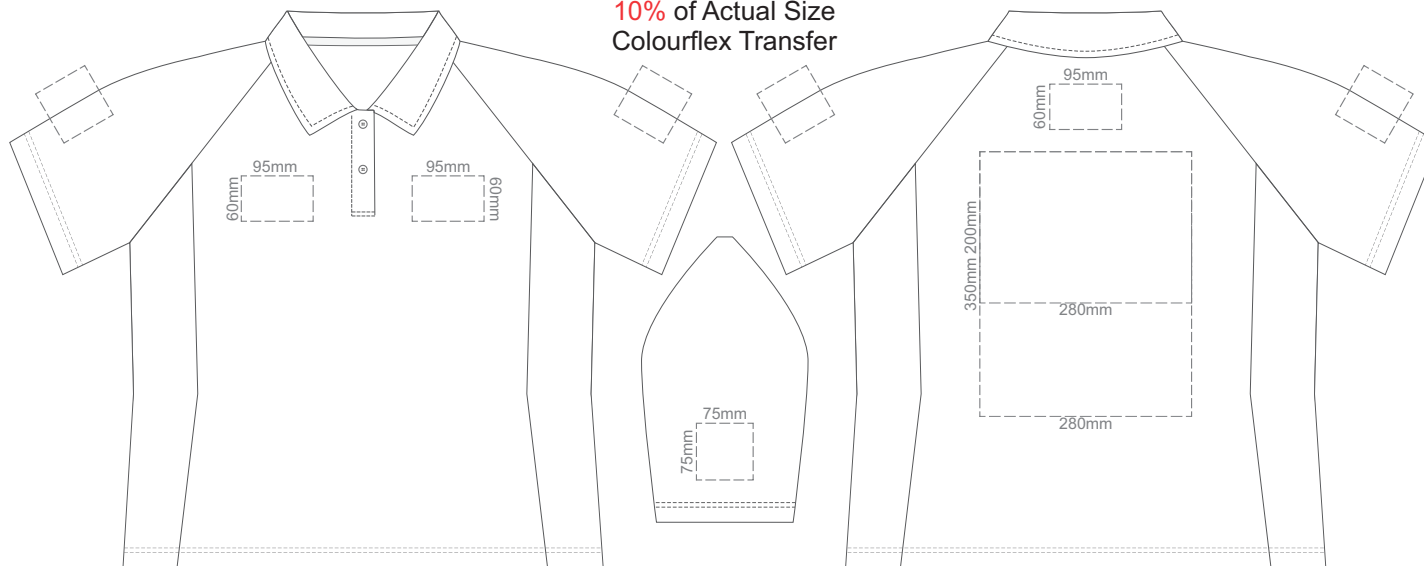

FRONT ADULT 3XL

Print area 280x200mm can be rotated to best suit.

BACK ADULT 3XL

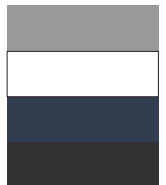

10% of Actual Size
Embroidery

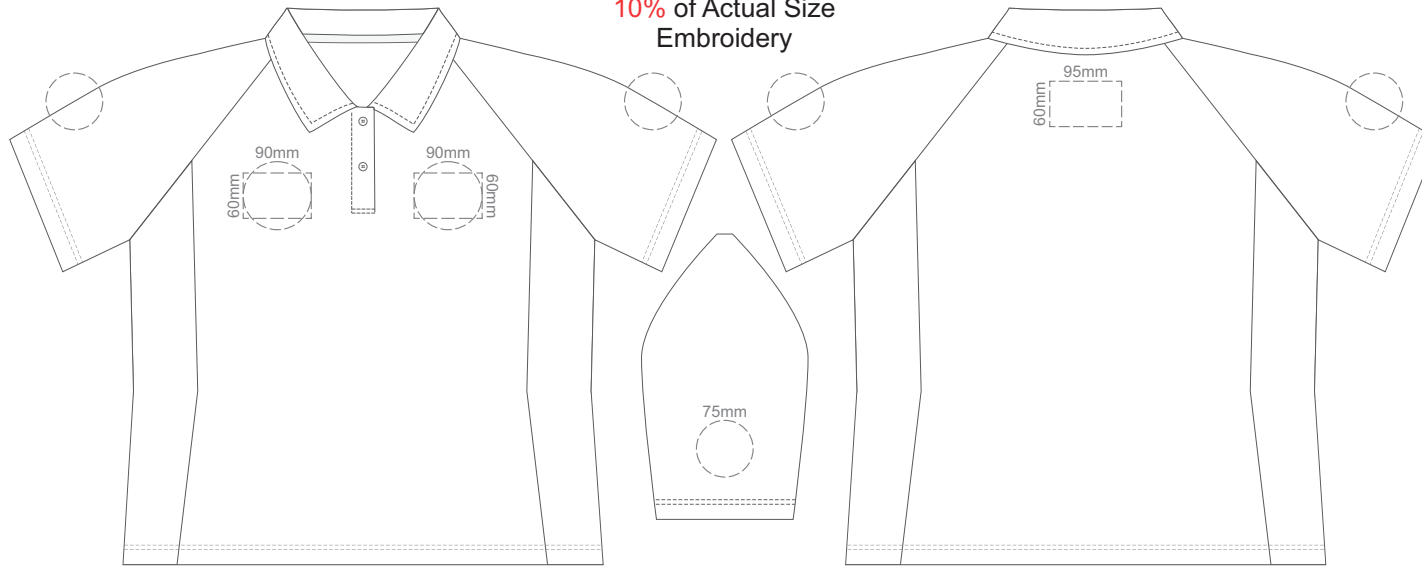

FRONT ADULT 3XL

BACK ADULT 3XL



10% of Actual Size
Screen Print

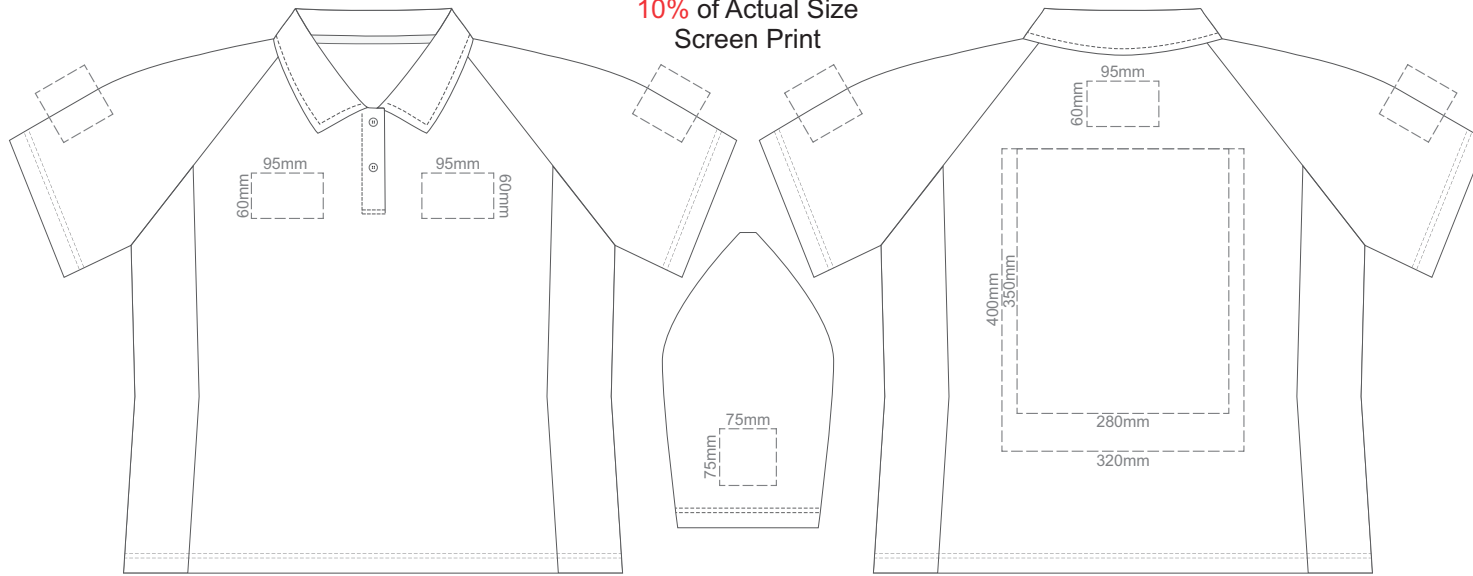

FRONT ADULT 4XL

BACK ADULT 4XL

10% of Actual Size
Colourflex Transfer

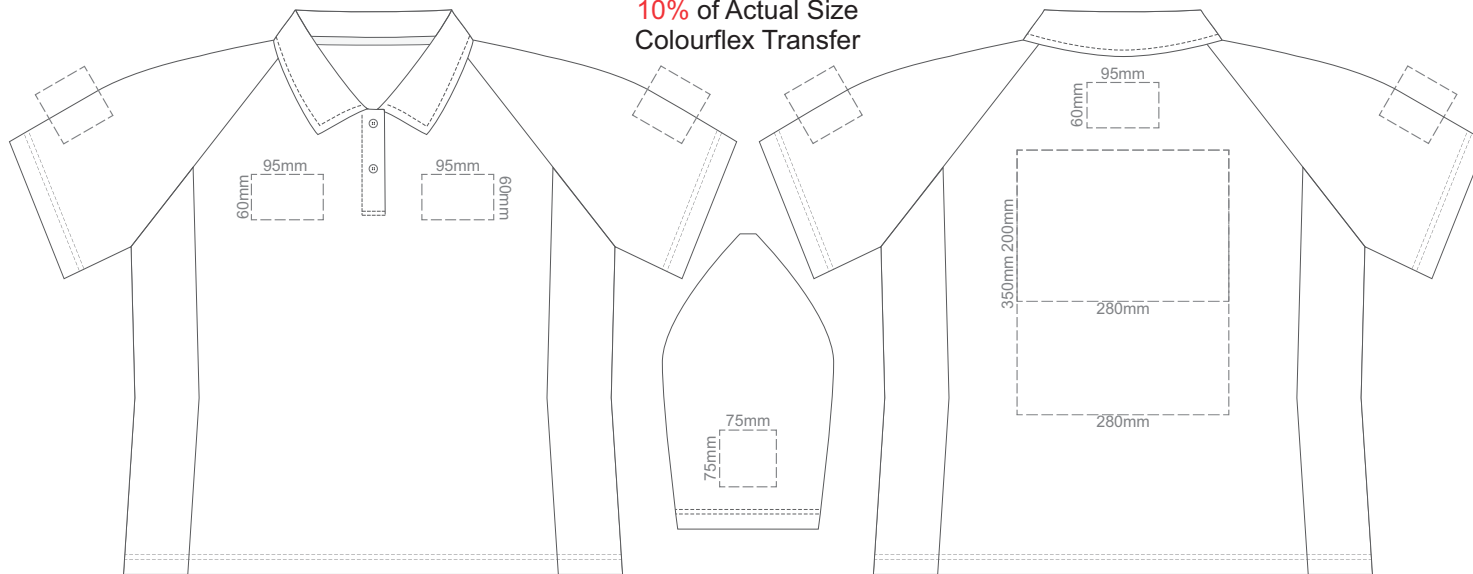

FRONT ADULT 4XL

Print area 280x200mm can be rotated to best suit.

BACK ADULT 4XL

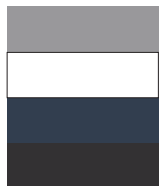

10% of Actual Size
Embroidery

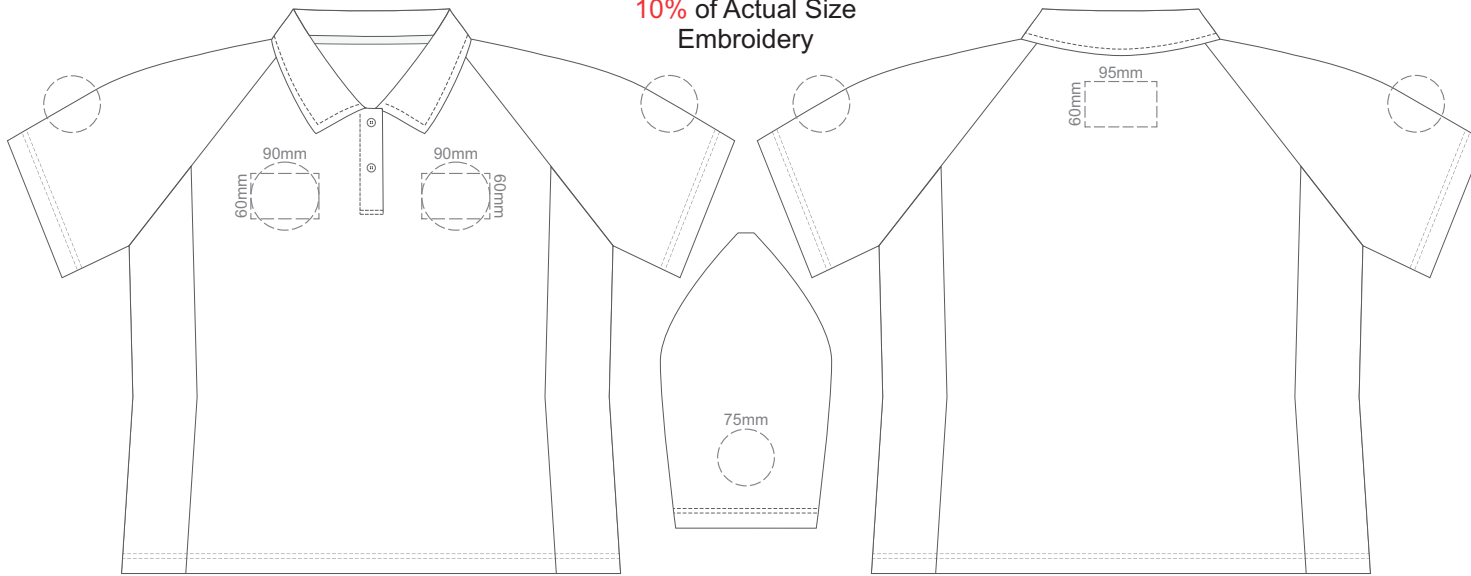

FRONT ADULT 4XL

BACK ADULT 4XL

